

BOTTOM WING SHOWN IN DASHED LINES

BAMBOO TIPS

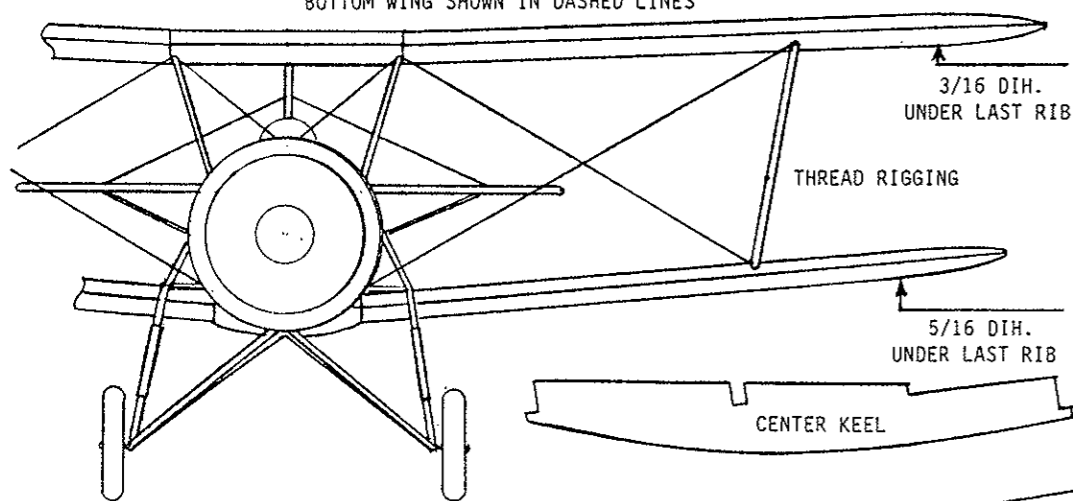

FRONT VIEW 1/2 SIZE

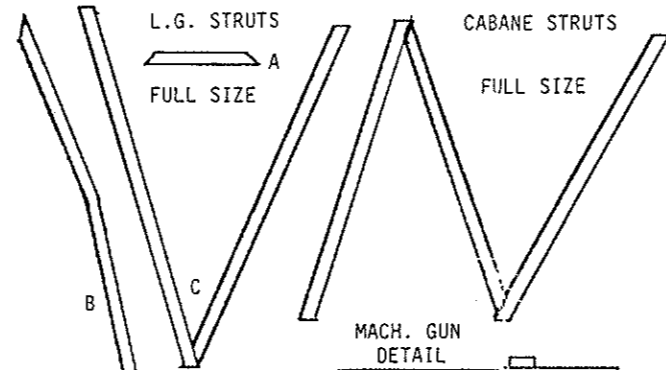

FULL SIZE BAY STRUTS

TOP AND BOTTOM WING USE SAME RIB

CONTROLS OUTLINED WITH BLACK PAPER STRIPS

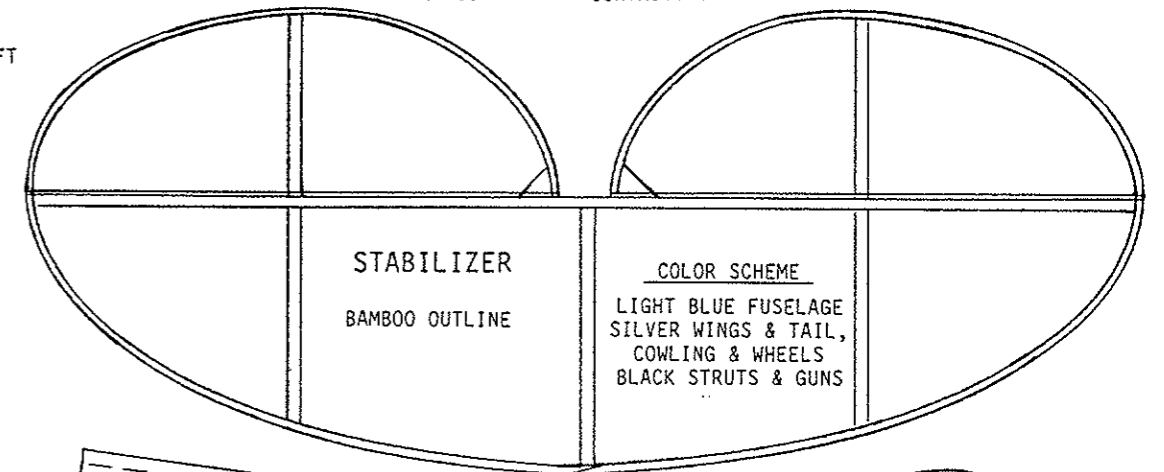

STABILIZER

COLOR SCHEME

LIGHT BLUE FUSELAGE
SILVER WINGS & TAIL,
COWLING & WHEELS
BLACK STRUTS & GUNS

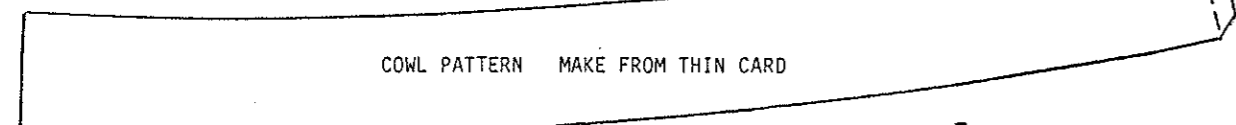

COWL PATTERN MAKE FROM THIN CARD

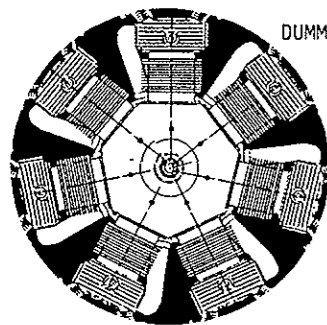

DUMMY MOTOR

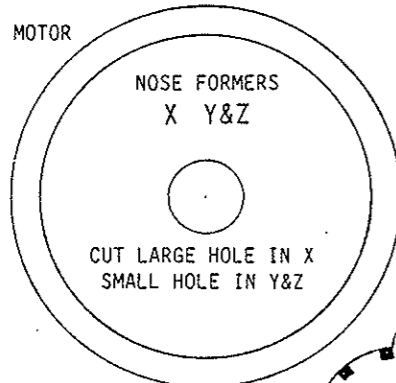

NOSE FORMERS
X Y & Z

CUT LARGE HOLE IN X
SMALL HOLE IN Y&Z

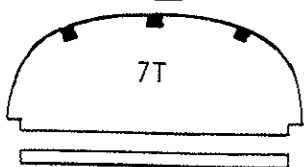

7T

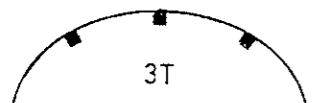

3T

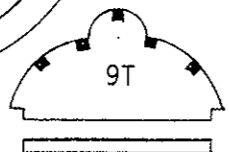

9T

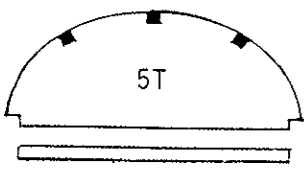

5T

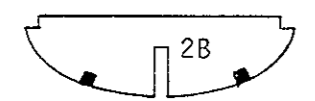

2B

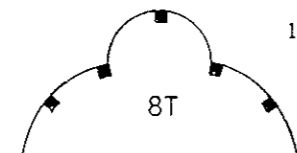

8T

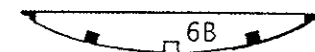

6B

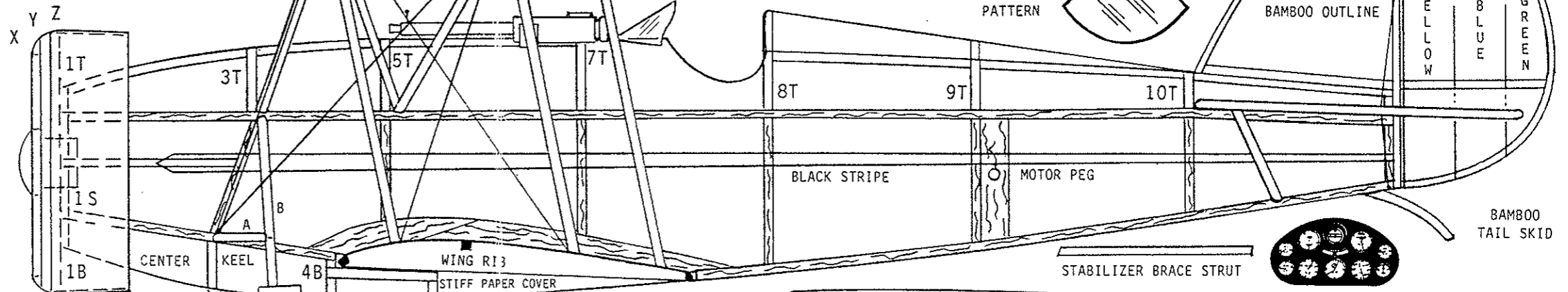

X Y Z



CENTER KEEL

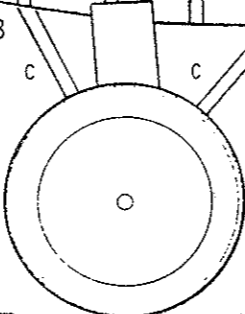

1 1/2 INCH Balsa WHEEL
USE PIN FOR AXLE

ALL WOOD 1/16

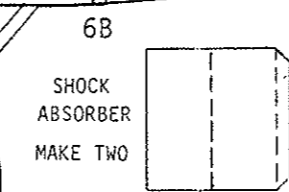

SHOCK
ABSORBER
MAKE TWO

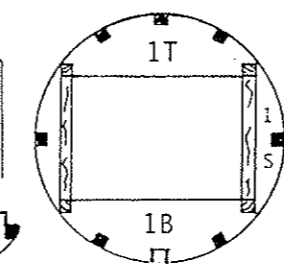

1T

1B

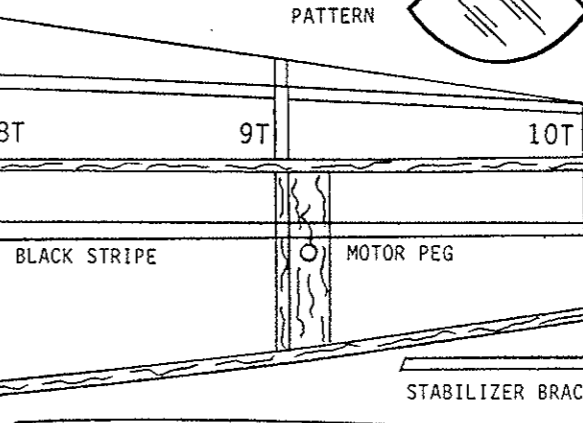

BLACK STRIPE

MOTOR PEG

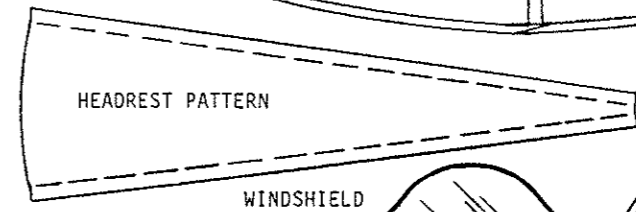

HEADREST PATTERN

WINDSHIELD
PATTERN

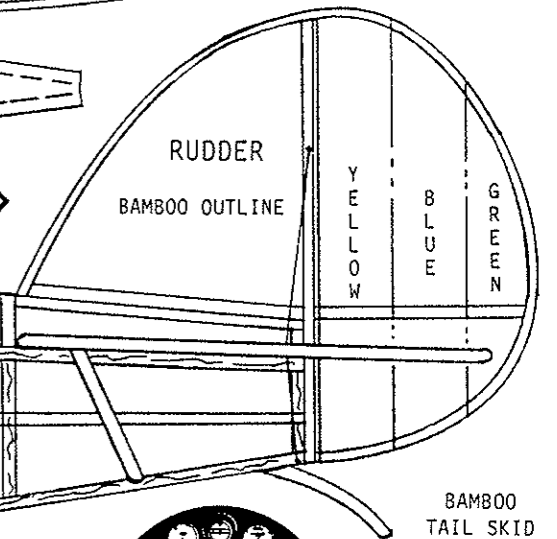

RUDDER

BAMBOO OUTLINE

YELLOW
BLUE
GREEN

BAMBOO
TAIL SKID

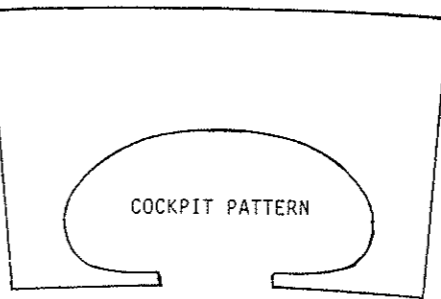

COCKPIT PATTERN

INSTRUMENT PANEL STICK TO 7T



AIRDEVIL MODEL CO.



WACO EXPEDITIONARY

WINGSPREAD- 16" PRICE- 10¢

DRAWN BY- Russ Hardy

TEST PILOT O.K. - Freddy Lund